

marantz®

Model CR2020 User Guide

MUSIC CONSOLE

CLASS 1 LASER PRODUCT
LUOKAN 1 LASERLAITE
KLASS 1 LASERAPPARAT

COMPACT
disc
DIGITAL AUDIO

	CAUTION RISK OF ELECTRIC SHOCK DO NOT OPEN	
CAUTION: TO REDUCE THE RISK OF ELECTRIC SHOCK, DO NOT REMOVE COVER (OR BACK) NO USER-SERVICEABLE PARTS INSIDE REFER SERVICING TO QUALIFIED SERVICE PERSONNEL		

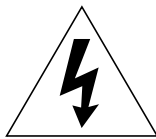

The lightning flash with arrowhead symbol, within an equilateral triangle, is intended to alert the user to the presence of uninsulated “dangerous voltage” within the product’s enclosure that may be of sufficient magnitude to constitute a risk of electric shock to persons.



The exclamation point within an equilateral triangle is intended to alert the user to the presence of important operating and maintenance (servicing) instructions in the literature accompanying the appliance.

WARNING

**TO REDUCE THE RISK OF FIRE OR ELECTRIC SHOCK,
DO NOT EXPOSE THIS APPLIANCE TO RAIN OR MOISTURE.**

**CAUTION: TO PREVENT ELECTRIC SHOCK, MATCH WIDE BLADE
OF PLUG TO WIDE SLOT, FULLY INSERT.**

**ATTENTION: POUR ÉVITER LES CHOCS ÉLECTRIQUES,
INTRODUIRE LA LAME LA PLUS LARGE DE LA FICHE DANS LA
BORNE CORRESPONDANTE DE LA PRISE ET POUSSER
JUSQU’AU FOND.**

NOTE TO CATV SYSTEM INSTALLER:

This reminder is provided to call the CATV (Cable-TV) system installer’s attention to Article 820–40 of the NEC, that provides guidelines for proper grounding and, in particular, specified that the cable ground shall be connected to the grounding system of the building, as close to the point of cable entry as practical.

NOTE:

This equipment has been tested and found to comply with the limits for a Class B digital device, pursuant to Part 15 of the FCC Rules. These limits are designed to provide reasonable protection against harmful interference in a residential installation. This equipment generates, uses and can radiate radio frequency energy and, if not installed and used in accordance with the instructions, may cause harmful interference to radio communications. However, there is no guarantee that interference will not occur in a particular installation. If this equipment does cause harmful interference to radio or television reception, which can be determined by tuning the equipment off and on, the user is encouraged to try

to correct the interference by one or more of the following measures:

- Reorient or relocate the receiving antenna.
- Increase the separation between the equipment and receiver.
- Connect the equipment into an outlet on a circuit different from that to which the receiver is connected.
- Consult the dealer or an experienced radio/TV technician for help.

NOTE:

Changes or modifications may cause this unit to fail to comply with Part 15 of the FCC Rules and may void the user’s authority to operate the equipment.

SAFETY INSTRUCTIONS

READ BEFORE OPERATING EQUIPMENT

This product was designed and manufactured to meet strict quality and safety standards. There are, however, some installation and operation precautions which you should be particularly aware of.

1. **Read Instructions** All the safety and operating instructions should be read before the appliance is operated.
2. **Retain Instructions** The safety and operating instructions should be retained for future reference.
3. **Heed Warnings** All warnings on the appliance and in the operating instructions should be adhered to.
4. **Follow Instructions** All operating and use instructions should be followed.
5. **Cleaning** Unplug this video product from the wall outlet before cleaning. Do not use liquid cleaners or aerosol cleaners. Use a damp cloth for cleaning.
6. **Attachments** Do not use attachments not recommended by the video product manufacturer as they may cause hazards.
7. **Water and Moisture** Do not use this video product near water for example, near a bath tub, wash bowl, kitchen sink, or laundry tub, in a wet basement, or near a swimming pool, and the like.
8. **Accessories** Do not place this video product on an unstable cart, stand, tripod, bracket, or table. The video product may fall, causing serious injury to a child or adult, and serious damage to the appliance. Use only with a cart, stand, tripod, bracket, or table recommended by the manufacturer, or sold with the video product. Any mounting of the appliance should follow the manufacturer's instructions, and should use a mounting accessory recommended by the manufacturer.
9. **Ventilation** Slots and openings in the cabinet are provided for ventilation and to ensure reliable operation of the video product and to protect it from overheating, and these openings must not be blocked or covered. The openings should never be blocked by placing the video product on a bed, sofa, rug, or other similar surface. This video product should never be placed near or over a radiator or heat register. This video product should not be placed in a built in installation such as a bookcase or rack unless proper ventilation is provided or the manufacturer's instructions have been adhered to.
10. **Power Sources** This video product should be operated only from the type of power source indicated on the marking label. If you are not sure of the type of power supply to your home, consult your appliance dealer or local power company. For video products intended to operate from battery power, or other sources, refer to the operating instructions.
11. **Grounding or Polarization** This video product is equipped with a polarized alternating current line plug (a plug having one blade wider than the other). This plug will fit into the power outlet only one way. This is a safety feature. If you are unable to insert the plug fully into the outlet, try reversing the plug. If the plug should still fail to fit, contact your electrician to replace your obsolete outlet. Do not defeat the safety purpose of the polarized plug.

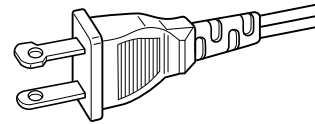

AC POLARIZED PLUG

12. **Power Cord Protection** Power supply cords should be routed so that they are not likely to be walked on or pinched by items placed upon or against them, paying particular attention to cords at plugs, convenience receptacles, and the point where they exit from the appliance.
13. **Protective Attachment Plug** The appliance is equipped with an attachment plug having overload protection. This is a safety feature. See Instruction Manual for replacement or resetting of protective device. If replacement of the plug is required, be sure the service technician has used a replacement plug specified by the manufacturer that has the same overload protection as the original plug.
14. **Outdoor Antenna Grounding** If an outside antenna or cable system is connected to the video product, be sure the antenna or cable system is grounded so as to provide some protection against voltage surges and built up static charges. Section 810 of the National Electrical Code, ANSI/NFPA No. 70 1984, provides information with respect to proper grounding of the mast and supporting structure, grounding of the lead in wire to an antenna discharge unit, size of grounding conductors, location of antenna discharge unit, connection to grounding electrodes, and requirements for the grounding electrode. See Figure 1.

LASER SAFETY

This unit employs a laser, Only a qualified service person should remove the cover or attempt to service this device, due to possible eye injury.

**CAUTION – USE OF CONTROLS OR ADJUSTMENTS
OR PERFORMANCE OF PROCEDURE
OTHER THAN THOSE SPECIFIED HEREIN
MAY RESULT IN HAZARDOUS RADIA-
TION EXPOSURE.**

15. **Lightning** For added protection for this video product receiver during a lightning storm, or when it is left unattended and unused for long periods of time, unplug it from the wall outlet and disconnect the antenna or cable system. This will prevent damage to the video product due to lightning and power line surges.
16. **Power Lines** An outside antenna system should not be located in the vicinity of overhead power lines or other electric light or power circuits, or where it can fall into such power lines or circuits. When installing an outside antenna system, extreme care should be taken to keep from touching such power lines or circuits as contact with them might be fatal.
17. **Overloading** Do not overload wall outlets and extension cords as this can result in a risk of fire or electric shock.
18. **Object and Liquid Entry** Never push objects of any kind into this video product through openings as they may touch dangerous voltage points or short out parts that could result in a fire or electric shock. Never spill liquid of any kind on the video product.
19. **Servicing** Do not attempt to service this video product yourself as opening or removing covers may expose you to dangerous voltage or other hazards. Refer all servicing to qualified service personnel.
20. **Damage Requiring Service** Unplug this video product from the wall outlet and refer servicing to qualified service personnel under the following conditions:
 - a. When the power supply cord or plug is damaged.
 - b. If liquid has been spilled, or objects have fallen into the video product.
 - c. If the video product has been exposed to rain or water.
- d. If the video product does not operate normally by following the operating instructions. Adjust only those controls that are covered by the operating instructions as an improper adjustment of other controls may result in damage and will often require extensive work by a qualified technician to restore the video product to its normal operation.
- e. If the video product has been dropped or the cabinet has been damaged.
- f. When the video product exhibits a distinct change in performance this indicates a need for service.
21. **Replacement Parts** When replacement parts are required, be sure the service technician has used replacement parts specified by the manufacturer or have the same characteristics as the original part. Unauthorized substitutions may result in fire, electric shock or other hazards.
22. **Safety Check** Upon completion of any service or repairs to this video product, ask the service technician to perform safety checks to determine that the video product is in proper operating condition.
23. **Carts and Stands** The appliance should be used only with a cart or stand that is recommended by the manufacturer.
24. An appliance and cart combination should be moved with care. Quick stops, excessive force, and uneven surfaces may cause the appliance and cart combination to overturn.



FIGURE 1
EXAMPLE OF ANTENNA GROUNDING ACCORDING TO
NATIONAL ELECTRICAL CODE INSTRUCTIONS
CONTAINED IN ARTICLE 810 - "RADIO AND TELEVISION EQUIPMENT"

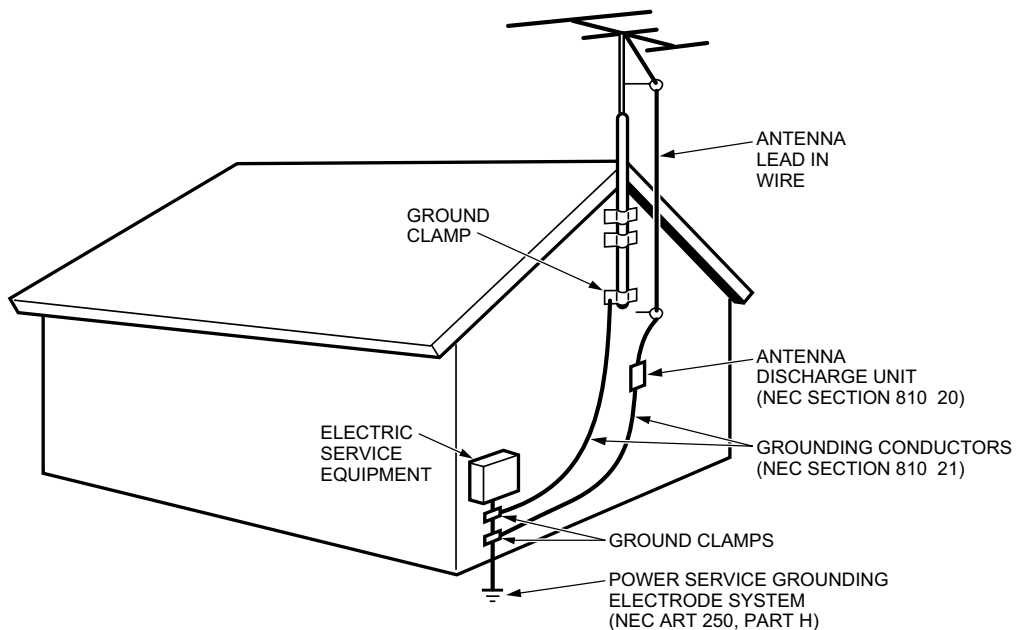

NEC NATIONAL ELECTRICAL CODE

This Class B digital apparatus meets all requirements of the Canadian Interference Cansing Equipment Regulations.

Cet appareil numérique de la Classe B respecte toutes les exigences du Règlement sur le matériel brouilleur du Canada.

K version

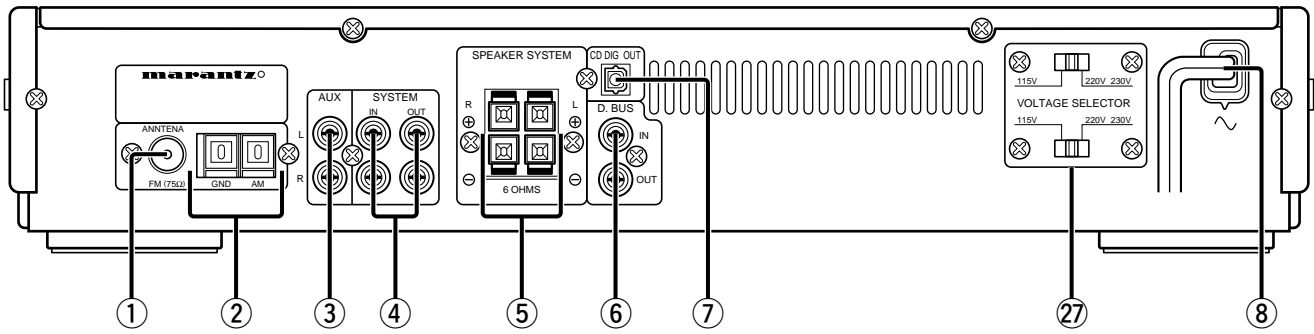

U version

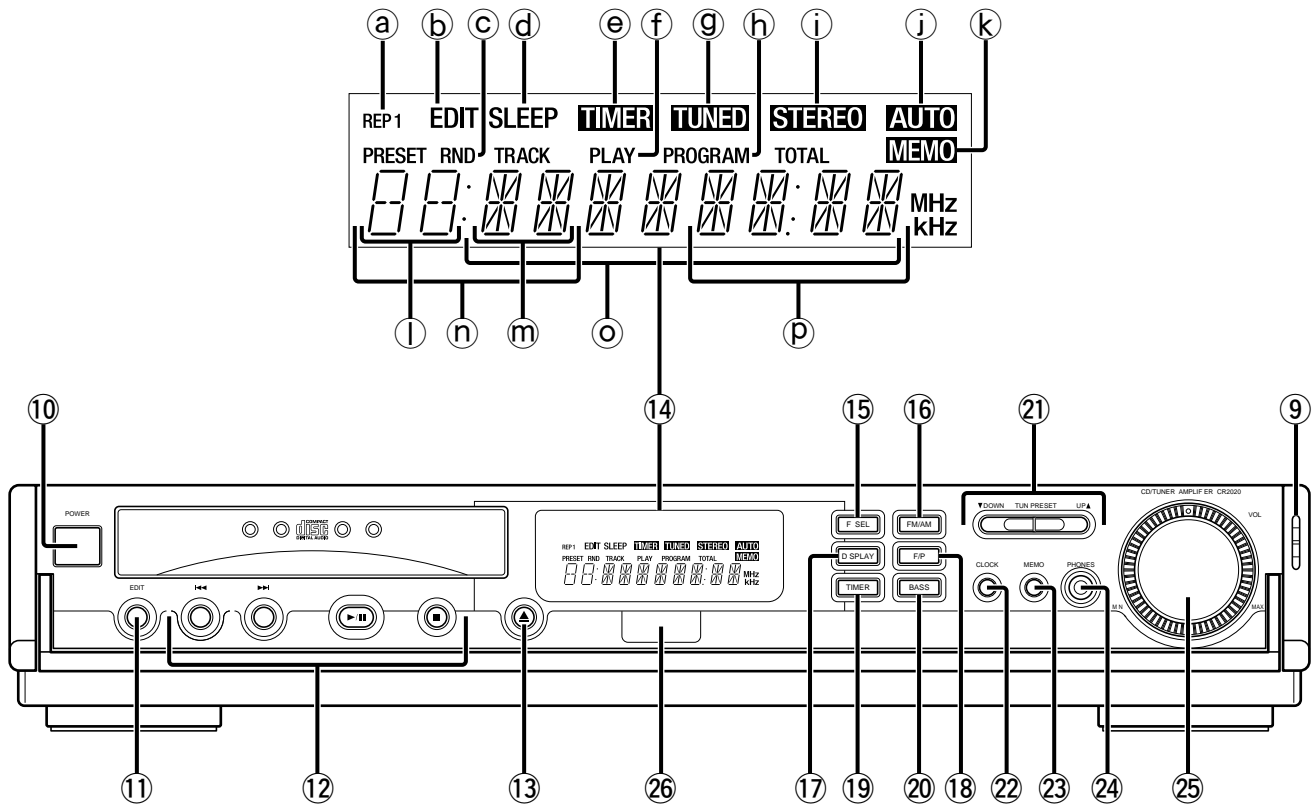
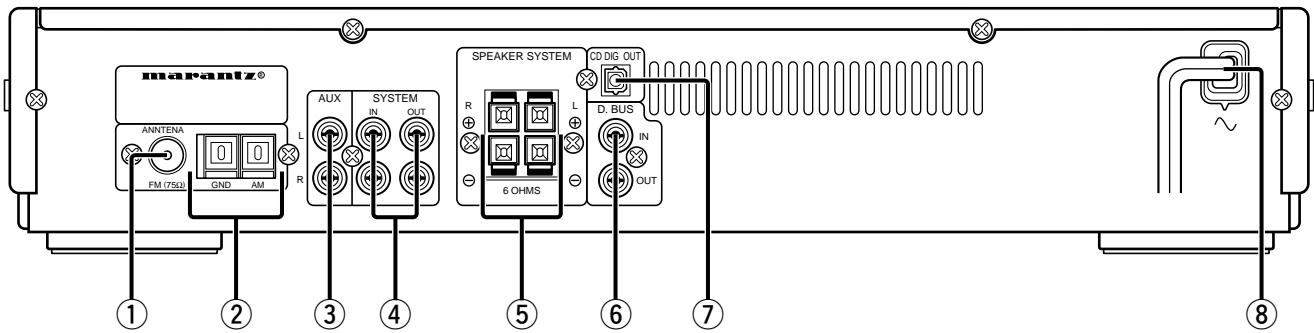

Figure 2

INTRODUCTION

Thank you for selecting the Marantz model CR2020 MUSIC CONSOLE for your audio system. This Stereo Cassette Deck incorporates a number of features designed to enhance the listening of your favorite audio sources.

Please read these operating instructions carefully. We recommend that you read the entire user guide before you attempt to connect or operate the unit.

After you have reviewed the contents of this manual, we suggest that you make all system connections before you attempt to operate the unit.

Refer to the Figures on pages 3 and 23 at the rear of this user guide. The callout numbers on the Figures correspond to those found in the text. All references to the connections and controls that are printed in **BOLD** type are as they appear on the unit.

PRECAUTIONS

The following precautions should be taken when operating the equipment.

GENERAL PRECAUTIONS

When setting the equipment ensure that:

- the ventilation holes are not covered
- air is allowed to circulate freely around the equipment
- it is on a vibration free-surface
- it will not be exposed to interference from an external source
- it will not be exposed to excessive heat, cold, moisture or dust
- it will not be exposed to direct sunlight
- it will not be exposed to electrostatic discharges

Never place heavy objects on the equipment.

If a foreign body or water does enter the equipment, contact your nearest dealer or service centre.

Do not pull out the plug by pulling on the mains lead, hold the plug.

It is advisable when leaving the house, or during a thunderstorm, to disconnect the equipment from the mains supply.

FEATURES

● Top-end models of the Slim Line Series

This model has a very slim shape and a height of 68 mm. All buttons except for the control knobs are concealed behind a front flap.

● High power output of 25 W + 25 W (DIN, into 6 ohms)

● Door open/close mechanism operates by means of a touch sensor

● 30-Station random preset tuner

Station names consisting of 8 characters can be stored together with the frequencies.

● System operation

This unit can be operated as a system component in combination with a MD Deck and tape deck of the Marantz Slim Line Series.

● 2-Program Timer/Sleep Timer

● System remote control

The remote control supplied with this unit can also be used to operate the MD Deck and tape deck of the Marantz Slim Line Series.

In this manual, the controls on the main unit are enclosed in a circle, e.g. ①, and the controls on the remote control are enclosed in a square, e.g. ①.

CONNECTIONS

Connection of D-BUS Remote Control Bus

This unit is equipped with the remote control bus function. By connecting it to Marantz system components equipped with remote control (D.BUS/RC 5) jacks, such as a MD Deck and tape deck, these components can be remote controlled from this unit.

Connect the D.BUS OUT jack of this unit to the REMOTE CONT.BUS IN jack of another component using an RCA-type pin lead.

NOTE:

- If the connected component with the remote control (D.BUS/RC 5) jacks has an INT/EXT switch on the rear panel, set the switch to EXT.

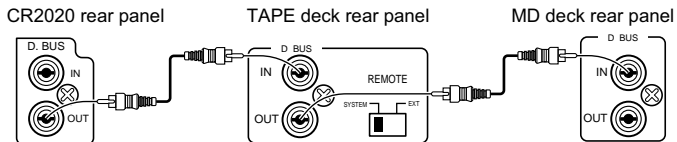

* Set to INT

- If this unit is to be connected to a MD Deck and tape deck of the Marantz Slim Line Series, refer to "System Connection through AL-Bus" shown in below figure.

System Connection through AL-Bus

- Use the following connections if this unit is to be used in combination with the Marantz Slim Line Series components.

NOTE:

If these components are to be stacked, always observe the stacking order shown in this illustration, that is, the receiver on top, the tape deck in the middle and the MD deck at the bottom.

SYSTEM (AL-BUS)

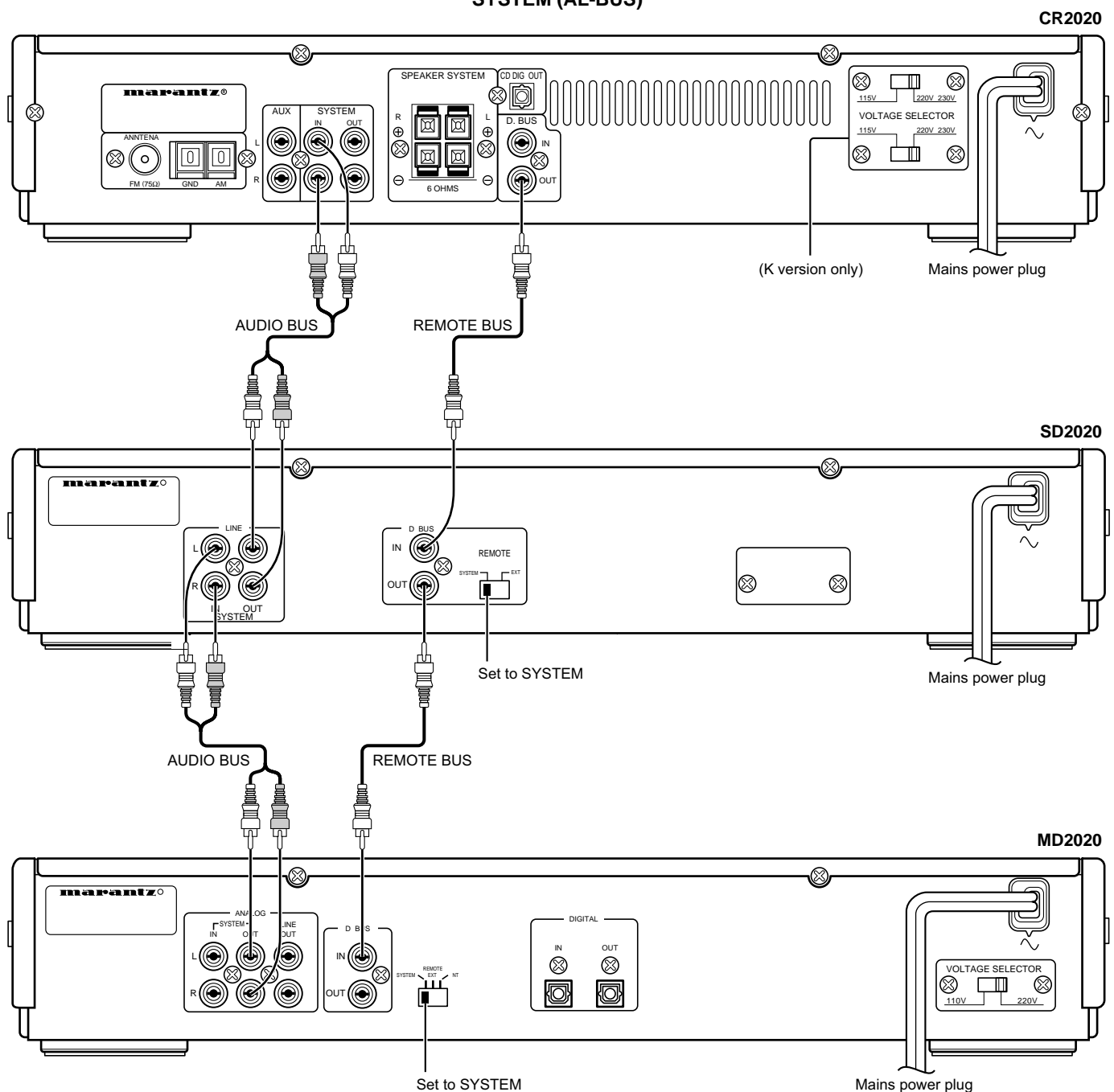

CONNECTORS AND CONTROL BUTTONS ON THE MAIN UNIT

① Terminal for FM antenna, 75 ohms

For connecting an external FM antenna with a circular plug, or for connecting a cable network.

② Terminals for AM antenna and earthing

To connect the AM loop antenna supplied, use the terminals marked "AM" and "GND".

In areas where the AM loop antenna gives unsatisfactory results, it is recommended that the receiver be connected to an outdoor antenna. Use the terminal marked "AM" for this. An earthing lead can be connected to the terminal marked "GND" to reduce interference further.

③ AUX input jacks

Connect to the audio output jacks of the second CD player, second tape deck, etc.

④ SYSTEM input/output jacks

SYSTEM input/output jacks connect the MD deck and tape deck etc. of MARANTZ slim line series.

⑤ SPEAKER SYSTEM terminals

Connect the left and right speaker leads, observing the + and - polarity of the leads and terminals.

⑥ D.BUS jacks

Connect to a component equipped with remote control (D.BUS/RC 5) jacks. (Refer to page 5.)

⑦ DIGITAL OUTPUT OPTICAL

This output supplies a digital signal via an optical path (optical-fibre cable and photocoupler) and can therefore be connected to a Digital Analog Converter (DAC), a Compact Disc Recorder (CDR), a Digital Compact Cassette deck (DCC), an amplifier with an optical digital input or a digital sound processor.

The output is covered with a protective cap which should only be removed when the output is in use.

⑧ Mains lead

Connect to a mains power outlet.

⑨ Touch sensor

When this elongated button is touched lightly, the front flap opens or closes automatically.

- The door cannot be closed while headphones are in use.

⑩ POWER switch

Press to turn power ON and press again to turn it OFF. The clock is displayed while the POWER switch is OFF.

When the switch is in the OFF position, the apparatus is NOT disconnected from the AC supply mains.

⑪ EDIT button

Selecting EDIT mode to enter the recording time when making a tape recording.

⑫ Main operation buttons

▶ / ⏸ (PLAY/PAUSE)

- Starting play.
- Interrupting play.

■ (STOP)

- Stopping play.
- Erasing a program.

⏮/⏭ (SKIP)





- Fast search for a particular passage; backwards to the beginning of the CD.
- Selecting another track during play.
- Selecting a track to start play with.
- Selecting tracks when compiling a program.
- Entering the recording time when making a tape recording (EDIT).

⑬ ▲ (OPEN/CLOSE) button

Opening and closing the CD compartment.

⑭ Display

This panel shows information on the status of the unit.

- Ⓐ REP1 : Lights up when a track is repeated.
- Ⓑ EDIT : Lights up when the player is switched to the EDIT mode.
- Ⓒ RND : Lights up during playback in random order.
- Ⓓ SLEEP : SLEEP indicator
- Ⓔ TIMER : Timer indicator
- Ⓕ PLAY : Lights up during playback.
- Ⓖ TUNED : Tuned indicator
- Ⓗ PROGRAM : Flashes when the player is switched to PROGRAM Mode.
Lights up during playback of a program.
- Ⓘ STEREO : STEREO indicator
- Ⓙ AUTO : FM AUTO indicator
- Ⓚ MEMO : Memory indicator
- Ⓛ  : Preset and Track indicator
- Ⓜ  : Shows the CD track number.
- Ⓝ  : Clock indicator
- Ⓞ  : Function/Station name/Frequency indicator
- Ⓟ TOTAL  : The elapsed playing time of the track being played;
The total playing time of the CD or a program (TOTAL);
The remaining playing time of the track being played;
The remaining playing time of the CD or a program;

⑮ F.SEL (Function Selector) button

The source changes as follows each time this button is pressed:



⑯ FM/AM button

Press to alternate between FM and AM.

⑰ DISPLAY button

Press to change the displayed content.

The display usually shows the station name, but shows the frequency when this button is pressed.

The frequency is also displayed during reception of a station which does not broadcast its station name. If this button is pressed during this, "NO NAME" is displayed for about 1 second.

Used to switch the time information display during CD playback.

⑱ F/P (Frequency/Preset) button

Press to change the function of the UP/DOWN buttons between the frequency change and preset number change.

19 TIMER button

This button is used when setting a timer program or checking the timer program contents after setting the timer. It is also used to cancel a set value.

20 BASS button

Press this button to boost the low frequencies. Press the button again to return to normal.

21 ▲ UP and ▼ DOWN buttons

Press these buttons to change the tuner frequency or preset channels. These buttons are also used to enter alphanumeric characters during timer setting or station name preset operation.

22 CLOCK button

Press to enter the clock display mode. If this button is pressed while the POWER switch is ON, the display changes to the clock display and then returns to the previous display in 5 seconds. Invalid during CD playback.

23 MEMO button

This button is used to store frequency preset, timer setting data, preset station name and clock data in the memory.

24 PHONES jack

For connecting a pair of stereo headphones. Plugging in the headphones turns the speaker sound off.

25 VOLume control

This knob adjusts the volume.

26 Infrared sensor

The infrared signal from the remote control enters the unit through this window. When remote controlling the unit, point the remote control transmitter toward this window.

(K version only)

27 VOLTAGE SELECTOR switches

Set both switches to the same positions according to your local voltage. Be sure to unplug the power cord from the power outlet before changing the position of these switches.

CONTROL BUTTONS ON THE REMOTE CONTROL

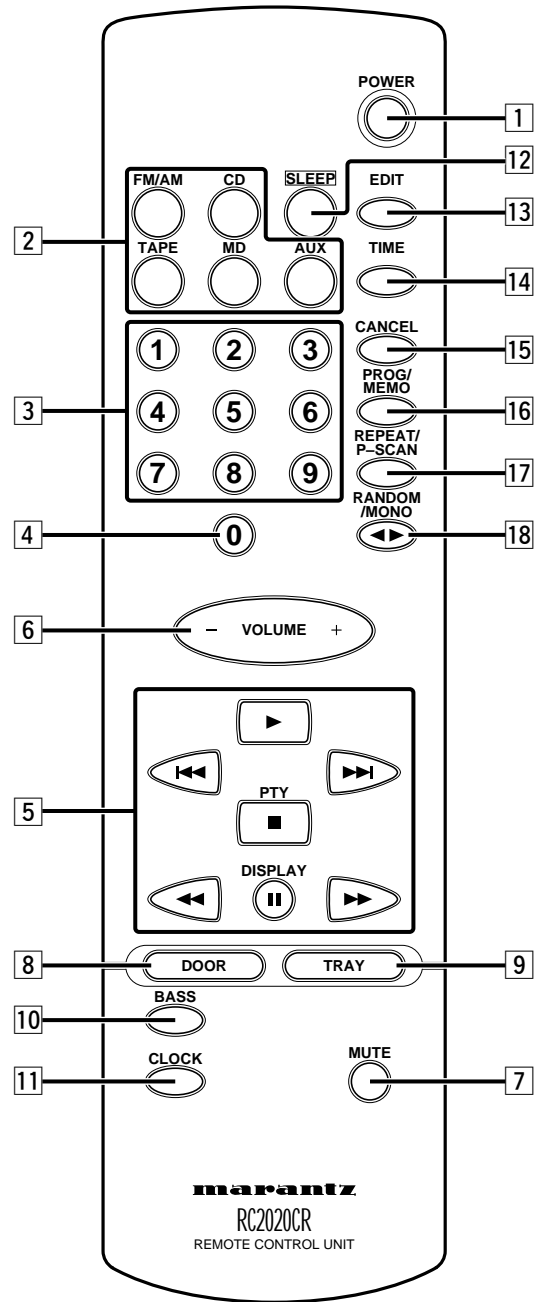

1 POWER switch

Press this switch to turn the power of the unit ON. Pressing the switch again turns the power OFF and the unit enters the standby mode.

2 Function buttons

CD, FM/AM, TAPE, MD, AUX. These buttons select the source to be played or recorded.

3 Numeric buttons 1 to 9

These buttons are used to enter figures in the selection of a tuner preset station, to set the clock or to set select a CD track number, etc. The functions of these buttons are dependent on the function button selected.

4 0 button

This button is used to enter the number "0" as well as to cancel various operations.

5 Control buttons

Play (▶), Stop (■), Pause (⏸), FF (▶▶), REW (◀◀).
 These buttons are used when operating the CD player, TAPE deck, MD player, etc.
 The functions of these buttons are dependent on the function button selected.

When TUNER is selected:

- Pause (⏸) Display button
- FF (▶▶) Tuning UP
- REW (◀◀) Tuning DOWN
- NEXT (▶▶) PRESET UP
- PREVIOUS (◀◀) PRESET DOWN

6 VOLUME +/- buttons

These buttons vary the listening volume. Press the + button to increase it and the - button to decrease it.

7 MUTE button

Press to mute the sound from the speakers. When this button is pressed, the speakers are muted and "MUTE" appears on the display of the main unit. Pressing the button again cancels the muting function, which can also be cancelled by pressing one of the function buttons.

8 DOOR button

If components of the Marantz Slim Line Series are connected through the AL-Bus, the DOOR button allows the doors on the system components to be opened or closed.

NOTE:

If the AL-BUS is not connected, OPEN/CLOSE operates the door on this unit only.

9 TRAY button

Opening and closing the CD compartment.

10 BASS button

Press this button to boost the low frequencies. Press the button again to return to normal.

11 CLOCK button

If this button is pressed while the POWER switch is ON, the display changes to the clock display and then returns to the previous display in 5 seconds.
 Invalid during CD playback.

12 SLEEP button

Press to set the sleep timer.

13 EDIT button

Selecting EDIT mode to enter the recording time when making a tape recording.

14 TIME button

Selecting the time information you want to see.

15 CANCEL button

- Erasing track numbers you do not wish to include in a program (TAKE-OUT programming).
- Erasing track numbers from a program.

16 PROG/MEMO button

This button is used to store a preset station in the memory or to program a CD track.

17 REPEAT/P-SCAN button

When CD is selected:

Repeat (used to repeat the same tracks).

When TUNER is selected:

Press to initiate the tuner preset scanning.
 Preset scanning receives the stations preset in the memory in sequence for 5 seconds per station. When the desired station is received, press the DOWN button; preset scanning is cancelled and the station can be received in normal reception.
 Pressing the UP button during preset scanning allows to skip the received station.

18 RANDOM/MONO button

When CD is selected:

Playing in random order.

When TUNER is selected:

Stereo/Mono (used to switch the tuner reception mode between stereo and mono).

When TAPE is selected:

Direction (used to select side A or B).

CAUTION

Danger of explosion if battery is incorrectly replaced.

Replace only with the same or equivalent type recommended by the manufacturer. Discard used batteries according to the manufacturer's instructions.

1. Remote control operation range

The remote control should be operated at a distance of less than 5 m from the infrared sensor of the unit. Be careful not to point the transmitter of the remote control in any direction other than towards the infrared sensor and ensure that there are no obstacles between the transmitter and infrared sensor, for these may make remote control operation impossible.

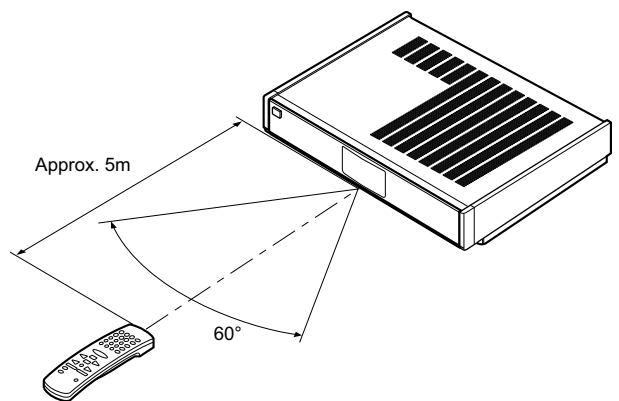

2. Loading batteries

Batteries in this remote control unit have a life of approximately 1 year under normal operating conditions. If the remote control unit is not going to be used for an extended period of time, remove the batteries. Also, if you notice that the batteries are starting to run down, replace them as soon as possible.

1) Remove the battery cover.

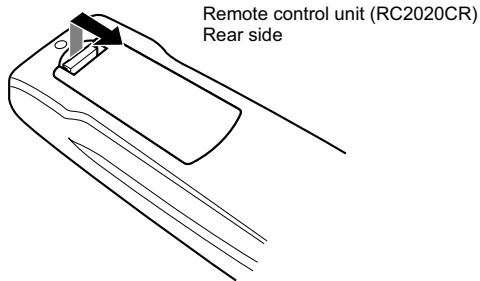

2) Insert the batteries with correct +/- orientation.

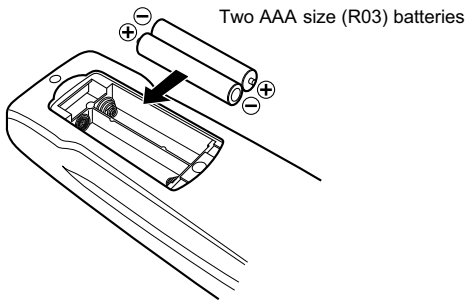

3) Close the battery cover until it clicks shut.

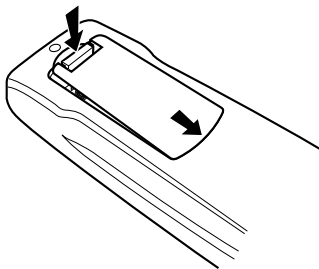

The battery life is about 1 year under normal use. The life is variable depending on the operating condition. If the unit is not to be used for a long period of time, be sure to take out the battery from the unit.

The RC2020CR Remote control is capable of controlling Marantz system components equipped with the D-Bus or AL-Bus jacks, such as a MD Deck and tape deck as well as this unit. Refer to "Connection of D-BUS Remote Control Bus" on page 5 or to "System Connection through AL-Bus" on page 5 and make the appropriate connections before proceeding to system control operation.

An example procedure for system operation is described below. Here, the case in which a TAPE Deck is connected to this unit through the AL-Bus is taken as an example.

1. Press the **POWER** switch [1] to turn the power of this unit ON.
 2. Press the **TAPE** function button [2] to set the remote control to TAPE mode.
 3. Press the **PLAY** ► control button [5] to play the tape deck.
 4. Press the **VOLUME** +/- buttons [6] to adjust the listening volume.
 5. Press the **STOP** ■ control button [5] to stop the tape deck.
 6. Press the **POWER** switch [1] to turn the power OFF.
- As described above, pressing one of the **FUNCTION** buttons [2] of the remote control switches the remote control mode so that the CD, tape deck or MD player can be controlled (Play, Stop, Pause, etc.).

Functions available with AL-Bus System Connection

The numbers of controls and buttons on the main unit are enclosed in ○, and those on the remote control are enclosed in □.

1. Synchronized power ON/OFF

Switching the **POWER** switch [10]/[1] ON/OFF also turns ON/OFF the power of the tape deck connected through the bus system connection.

2. Synchronized door open/close

Pressing the **DOOR** button [8] of the remote control opens or closes the doors of the components in the system.

3. Auto operation

When the tape deck is operated, the system switches over automatically to the component which is playing.

4. Simple connection

The system can be connected very easily with a small number of cables.

PLAYING A PROGRAMME SOURCE

Normal play

1. Set the **VOLUME** control [25]/[6] to the minimum position.
2. Press the **POWER** switch [10]/[1] to turn the power ON.
3. Press the optimum function button [15], [16]/[2] for the source to be played by referring to the table below.
4. Start playing the source component.
Adjust the listening volume with the **VOLUME** control [25]/[6].

Source to be played	Function button [15], [16]/[2]
CD	CD
FM/AM	FM/AM
AUX (second tape deck, etc.)	AUX
MD player	MD
Cassette tape deck	TAPE

To record sound onto a tape or MD:

Use the following procedure when recording, for example, CD onto a cassette tape or MD.

1. Press the function button [2] of the source to be recorded. In this example, press the **CD** function button.
2. Operate the CD player.
3. Operate the tape deck to record the CD onto a cassette tape.
The recorded sound will be the same as that reproduced through the speakers.

TUNER OPERATION

The number of controls and buttons on the main unit are enclosed in ○, and those on the remote control are enclosed in □. Before proceeding to tuner operation, press the **FM/AM** function button [2] of the remote control to set the remote control in the tuner mode.

To listen to the tuner

1. Set the **VOLUME** control [25] to the minimum position.
2. Press the **POWER** switch [10]/[1] to turn the power ON.
3. Press the **FM/AM** button [16] or the **FM/AM** function button [2] to select the radio band to be received.
4. Press the **F/P** button [18] to select the frequency display.
5. Press the **▲ UP** or **▼ DOWN** button [21]/[5] to scan the frequency. Pressing the button for less than 0.5 second scans the frequency by 1 step. Holding the button depressed scans the frequency continuously. When the button is released in this mode, auto tuning starts. Auto tuning stops automatically when a broadcasting station is tuned into, and the **TUNED** indicator lights up.
6. Adjust the volume with the **VOLUME** control [25]/[6].
The following operation is available only on the remote control. When receiving the FM band, set the desired audio mode with the **MONO** button [18].

When the AUTO indicator is lit up:

When a stereo programme is being received, the **STEREO** indicator lights up and the programme is received in stereo.

To receive sound in mono, press the **MONO** button so that the **AUTO** indicator goes off.

(K version only)

Switching the AM scanning step

To switch the AM scanning step to 10 kHz, select AM with the **FM/AM** button [16] then press and hold the **STOP** [12] and **MEMO** [23] buttons simultaneously for 3 seconds. "AMSTEP10" appears on the display and the AM scanning step is set to 10 kHz. To return the AM scanning step to 9 kHz, press and hold the **STOP** [12] and **MEMO** [23] buttons simultaneously for 3 seconds in the same way as above. "AMSTEP 9" appears on the display and the AM scanning step is returned to 9 kHz.

PRESET MEMORY OPERATION

This unit can store up to 30 stations selected randomly in the FM and AM bands.

The preset memory function allows the frequency, receiving mode and also the station name to be stored in the memory.

The preset memory can be jilled in two ways:

Manual preset memory

1. Select a desired station, referring to "Tuner Operation".
2. Press the **MEMO** button [23]/[16].
The **MEMO** indicator will blink for approx. 5 seconds. In this period, select the preset number with one of the following procedures.
 - * Select the preset number with the **▲ UP** or **▼ DOWN** button and press the **MEMO** button [23]/[16].
 - * Select the preset number by directly entering it with the numeric buttons. (Remote control only)

NOTE:

It is recommended that numbers from 1 to 3 be entered as two digits, e.g. 01 to 03. They can also be entered as one digit, but a waiting period of 1.5 seconds is required in this case.

Auto preset memory (main unit only)

This allows a band to be scanned automatically, a station with good reoperation to be found and to be and stored in the preset memory.

1. Select the desired band and frequency.
2. While holding the **MEMO** button [23] depressed, press the **▲ UP** button [21]. The auto preset memory operation starts.
Starts auto scanning within the band.

3. The **MEMO** indicator flashes on the display.
4. When a station is received, scanning pauses for 5 seconds. In this period, the following operations can be performed.
 - 1) Changing the band [21].
5. If no button is pressed in the period above, the frequency being received is stored. If the **▲ UP** button [21] is pressed in the 5-second period, scanning restarts without storing the frequency being received in the memory.
6. When stations up to [P30] have been preset, auto preset memory is automatically stopped.
To stop in mid-operation, press one of the function buttons [15], [16] or, on the remote control, press one of the function buttons [2] or the **O** button [4].

Station name preset

The station name preset function allows the name of each preset channel to be entered using alphanumeric characters.

The Station Name button is valid only in the tuner mode and the preset number display mode.

Before station name preset operation, store stations with the preset memory operation described on the previous page.

1. Press and hold the **MEMO** button for more than 3 seconds.
2. The leftmost column of the station name indicator flashed, indicating the character entry ready status.

[Operation using the buttons on the main unit]

3. When the **▲ UP** button [21] is pressed, alphabetic and numeric characters will be displayed in the following order:

A → B → C...Z → 1 → 2 → 3...0 → - _ (Blank) → A
 UP →
 ← DOWN

Holding the button depressed displays alphanumeric characters at high speed, and pressing the **▼ DOWN** button reverses the order.

4. After selecting the first character to be entered, press the **MEMO** button [23]. The entry in this column is fixed and the next column starts to flash. Fill the next column and press the **MEMO** button [23] for more than 3 second to confirm the entry.

NOTE:

Unused columns should be filled by entering blanks.

[Operation using the buttons on the remote control]

3. Enter the character using the numeric buttons [3] [4].
For example, to enter "A":
 - 1) Press the "1" button. "A" appears on the display column.
 - 2) Every time the "1" button is pressed, the displayed character changes in the order: A → B → C → 1 → A ...
Pressing buttons other than the "1" button cause different characters to be displayed in a similar way, so that other alphanumeric characters can be entered.
To enter a blank or space, press the "9" button.
4. When the desired character is displayed, press the **PROG/MEMO** button [16] to confirm the entry in this column and move to the next column.
After having filled all of the 8 columns, press the **PROG/MEMO** button [16] for more than 3 second again.

Recalling a station from the preset memory (remote control only)

1. Direct selection by pressing numeric buttons [3] [4]:
Enter an integer from 1 to 30. 1-digit preset numbers 1 to 9 should be preceded by 0, for example "05". The entry is complete when the second digit has been entered.
2. Selection using **▶▶** or **◀◀** buttons [5]
Each press of the **▶▶** or **◀◀** button [5] increases or decreases the preset number by one, holding the button depressed changes the preset numbers at a high speed and releasing the button stops the high-speed change.

Preset scan tuning

1. Press the REPEAT/P SCAN button [17].
The PRESET indicator flashes on the display, and the display enters the preset number display mode. (The smallest preset number is recalled at this time. If no station has been preset, "P00" flashes and the display returns to the previous contents.)
2. Preset scan starts endlessly advancing to the next preset number, for example from P1 to P2, every 5 seconds. The preset numbers which do not correspond to any preset memory are skipped.
3. Preset scanning can be accelerated by holding the UP or DOWN [21], [5] or [21], [5] button depressed.
Preset scanning can be cancelled by pressing the P SCAN [17] button.
It can also be cancelled by pressing the 0 button [4].

Clearing the preset memory (remote control only)

The preset memory contents can be cleared with the following procedure.

1. Recall the preset number to be cleared with the [21], [5] or [21], [5] button [5].
2. Press the PROG/MEMO button [16] and, while the MEMO indicator flashes for 5 seconds, press the "0" button [4]. The CLEAR indicator is displayed and the contents of that preset number are cleared.

PRESENT TIME SETTING

Setting the current time of the day

The initial clock display is "0:00".
Press the POWER switch to turn power ON.
The current time can be set and displayed either in 12-hour or 24-hour system.

Example: To set the current time to 13:30 (1:30PM)

- | Button Operation | Display |
|--|----------------|
| 1. Press the CLOCK button and, while the CLOCK indicator is lit, press the MEMO button [23]/[16]. | |
| 2. The MEMO indicator blinks. Press the ▲ UP/▼ DOWN button to display "24H" (if you want the 24-hour display). | MEMO flashing. |
| <ul style="list-style-type: none"> • If you want the 12-hour display, press the ▲ UP/▼ DOWN button to display "PM" (or "AM"). | |
| 3. Press the CLOCK button. Now the 24-hour or 12-hour display system has been selected. | |
| 4. The left figures of the digital display blink. Press the ▲ UP/▼ DOWN button to display "13". | |
| <ul style="list-style-type: none"> • To set the time in 12-hour system, press the ▲ UP/▼ DOWN button to display "1" and "PM". | |
| 5. Press the CLOCK button. Now the figures of hour have been set. | |
| 6. The right figures of the digital display blink. Press the ▲ UP/▼ DOWN button to display "30". | |
| 7. Press the CLOCK button. Now the figures of minute have been set. | |

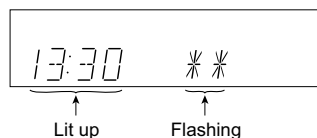
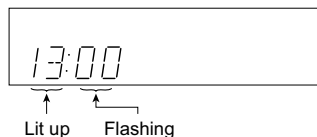
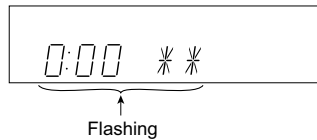

8. Listen to the time announcement on telephone or radio, and press the MEMO button [23]/[16] when the time of the day becomes 13:30. Now the clock starts.

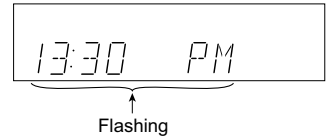

- To have the program timer function properly, be sure to set the time of day beforehand.
- To correct the time, press the CLOCK button for the required number of times to switch the blinking indicator or digits and correct in the same way as for setting the time.

Setting the program timer

The program timer can store data for the following operations.

- (1) Two timer setup programs.
- (2) ON time and OFF time of each program.
- (3) Operation mode.
Select from CD, TAPE, MD and TUNER (preset No. 1 to 30).
- (4) "Once" operation or "Daily" operation.

1. Press the POWER switch [10]/[1] to turn power ON.
2. Press the TIMER button [19].
The TIMER indicator blinks in the display.
3. Press the MEMO button [23]/[16] within 5 seconds.
The MEMO, TIMER and PRG-1 indicators blink in the display, indicating that the unit is in the program timer setting mode.
4. Press the ▲ UP/▼ DOWN button [21]/[5] to select PRG-1 or PRG-2, then press the MEMO button [23]/[16].
5. The display shows "0:00 ON". Press the ▲ UP/▼ DOWN button [21]/[5] to set the "hour" of the time for turning power ON (ON time), and press the MEMO button [23]/[16].
6. Press the ▲ UP/▼ DOWN button [21]/[5] to set the "minute" of the ON time, and press the MEMO button [23]/[16].
7. The display shows "-:-- OFF". Set the OFF time in the same way for setting the ON time.
- "-:--" shows the previously set ON time.
8. The display shows "CD". Press the ▲ UP/▼ DOWN button [21]/[5] to select the operation mode from CD, TAPE, MD and TUNER, and press the MEMO button [23]/[16] to set the selection.
- When the operation mode is set to TUNER:
Select a preset number with the ▲ UP/▼ DOWN button [21]/[5] and press the MEMO button [23]/[16] to set it. If preset numbers have not been set, this returns to the operation mode setting step.
9. The display shows "ONCE".
Press the ▲ UP/▼ DOWN button [21]/[5] to select "ONCE" or "DAILY", then press the MEMO button [23]/[16] to set the selection.
The TIMER indicator lights to indicate that the setting is complete.
- With ONCE, the timer program memory is cleared after it has been executed once. With DAILY, the programmed timer operation will be repeated every day.
- If the operation mode selected during timer programming cannot be activated at the ON time, the power is turned ON in TUNER mode.

NOTE:

Timer operation of MD and TAPE can be activated only when the corresponding equipment is a MARANTZ Slim Line component connected to the main unit through a system cord.

Caution in Timer Play.

- A. Be sure to set the present time before setting the timer operation.
- B. If the times set for two timer programs overlap, the timer will operate as follows.

- 1) If the ON time of one program comes after the ON time of the other program:
(Example)



In the case shown on the left, PRG-2 is not executed.

- 2) If the ON time of one program coincides with the OFF time of the other:
(Example)



In the case shown on the left, PRG-2 is also executed.

- C. While setting the timer, units except for receiver cannot be operated. Be sure to operate the units after completion of the timer setting.

The set timer programs can be cancelled temporarily when they are not required.

1. If the timer indicator is displayed, press the **TIMER** button [19]. When the timer program contents start to be displayed, press the **TIMER** button [19] again.
 2. The timer indicator disappears from the display, and the timer program will not be executed. The timer program can be re-activated by pressing the **TIMER** button [19] again to display the **TIMER** indicator.
- If both PRG-1 and PRG-2 have been set, it is not possible to temporarily cancel only one of them.

Checking the program timer

1. Press the **TIMER** button [19].
If no timer program has been set, the **TIMER** indicator blinks for 5 seconds, after which the unit returns to the previous condition.
 2. If a timer program has been set, the information is displayed in the following order, for 2 seconds per each item.
 1. Program 1 or 2
 2. ON time
 3. OFF time
 4. Operation mode
(If the operation mode is TUNER, the program number will be displayed after 4.)
 5. DAILY or ONCE
- When both programs 1 and 2 have been set, the information 1 to 5 is displayed separately for each program.

Clearing a program

Use the following procedure to clear a previously set program.

1. Press the **TIMER** button [19].
The program timer check starts.
 2. When the program to be cleared (PRG-1 or PRG-2) is displayed, press the **MEMO** button [23/16] then press numeric button **0/CL** button of the remote control unit.
Now the program has been cleared.
- Before pressing the numeric button, press the **FM/AM** button [2] of the remote control unit.
 - If you just want to stop a timer operation temporarily, see description in "When you do not want to execute a program timer setting".

Sleep Timer Setting (remote control only)

The sleep timer function allows the power of the unit to be turned OFF automatically after a specified period of time.

1. While the power is ON, press the **SLEEP** button [12].
2. The display shows "SLEEP 10" for 5 seconds (with "10" blinking).
3. Press the **SLEEP** button [12] in less than 5 seconds. Each press changes the sleep timer period in order of 10 → 20 → 30 → 40 → 50 → 60 → 90 → 120 → -- (OFF) → 10....
4. When the desired period is displayed, leave the controls for 5 seconds; "SLEEP" will light indicating the completion of set-up and at the same time the sleep timer will start the count.

Press the **SLEEP** button [12] during counting of sleep timer to display the remaining period until the power is turned OFF.

To change the set-up period after the sleep timer has started the count, display the remaining time, press and hold the **SLEEP** button [12] for more than 1 seconds while the remaining period is displayed, and repeat steps 2 to 4 above.

To cancel the sleep timer operation...

Press the **SLEEP** button [12] then, while the remaining time is displayed, press numeric button **0/CL** of the remote control unit. Alternately, start the sleep timer setting operation and set the desired time to -- (OFF).

- Before pressing the numeric button, press the **FM/AM** button [2] of the remote control unit.

OPERATION

CD playback

1. Set the volume control to the minimum.
2. Press the **POWER** switch [10/1] to ON.
3. Press the **CD OPEN/CLOSE** button ▲ on the set or the **TRAY** button [9] on the remote control unit.
When the CD tray opens, place a disc on it with the labeled side up.

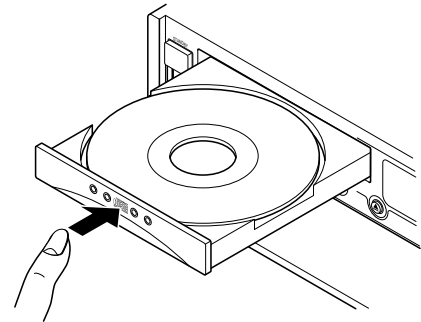

4. Lightly push the front of the CD tray or press the **CD OPEN/CLOSE** button ▲ on the set or the **TRAY** button [9] on the remote control unit to close the CD tray.

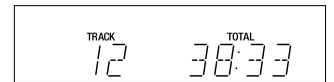

"DISC" flashes on the display, then the total number of tracks on the disc and their total playing time are displayed.

- The display will not change if the function is set to anything other than CD.
To set the function to CD, press the **STOP** button ■ on the set or the **STOP** button ■ on the remote control unit.
The function can also be set to CD by pressing the **PLAY/PAUSE** button ►/|| on the set or the **PLAY** button ► on the remote control unit. In this case playback starts after "DISC" flashes on the display, and the total number of tracks on the disc and their total playing time are not displayed.

- Press the **PLAY/PAUSE** button **▶/||** on the set or the **PLAY** button **▶** on the remote control unit to start playback.

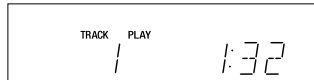

The display shows the number of the currently playing track and its elapsed playing time.

- If playback or other operations are not possible from the remote control unit, the remote control unit is set to a mode other than CD. In this case, press the **CD** button on the remote control unit twice to set the mode to CD.

To pause playback

During playback, press the **PLAY/PAUSE** button **▶/||** on the set or the **PLAY** button **▶** on the remote control unit.

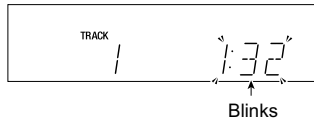

Playback pauses at the position where the button is pressed.

- To resume playback, press the **PLAY/PAUSE** button **▶/||** on the set or the **PLAY** button **▶** on the remote control unit again.

To stop playback

Press the **STOP** button **■** on the set or the **STOP** button **■** on the remote control unit.

To take out the disc

Press the **CD OPEN/CLOSE** button **▲** on the set or the **TRAY** button **9** on the remote control unit to open the CD tray, take out the disc, then lightly push the front of the CD tray or press the **CD OPEN/CLOSE** button **▲** on the set or the **TRAY** button **9** on the remote control unit to close the CD tray.

- Keep the CD tray closed when not using the set.

Search/skip operations

Search (To play the desired position)

- To search for a position located before the current position during the play or pause mode, press and hold the **SKIP** **◀◀** button on the set or the **SEARCH** **◀◀** button on the remote control unit for at least 0.5 seconds.
- To search for a position located after the current position during the play or pause mode, press and hold the **SKIP** **▶▶** button on the set or the **SEARCH** **▶▶** button on the remote control unit for at least 0.5 seconds.
- When search is started in the play mode, normal playback resumes from the position where the button is released.
- When search is started in the pause mode, the pause mode is set at the position where the button is released.
- The search speed is slow and the sound is audible for the first three seconds after the button is pressed. After this searching is performed at high speed.

Skip (To skip to the beginning of the specified track)

Use the **SKIP** buttons **▶▶** and **◀◀** on the set or the number buttons (0 to 9) **3** or **SKIP** buttons **▶▶** and **◀◀** on the remote control unit to specify the track.

Specifying the track number using the number buttons (0 to 9) **3** on the remote control unit:

- To specify track No. 3 → Press 3.
- To specify track No. 12 → Press 1, then press 2 within two seconds.
- "ERROR" is displayed if a track that does not exist on the disc is specified. If this happens, specify an existing track number.

Specifying the track number using the **SKIP** buttons on the set or the remote control unit (**▶▶** and **◀◀** or **▶▶** and **◀◀**):

- Press the **SKIP** **▶▶** button once to increase the track number by one.
- Press the **SKIP** **◀◀** button once to decrease the track number by one.
- If the button is pressed once, the beginning of the currently playing track is specified.
- When a track number is specified during playback, normal playback starts from the beginning of the specified track.

- When a track number is specified in the pause mode, the pause mode is set at the beginning of the specified track.
- When a track number is specified during the stop mode, playback starts from the beginning of the specified track.

Repeat playback

The repeat mode switches each time the **REPEAT/P SCAN** button on the remote control unit is pressed.

All-track repeat: All the tracks on the disc are played repeatedly.

All track repeat display



1-track repeat: The specified track is played repeatedly.

1 track repeat display

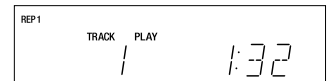

- To cancel repeat playback, press the **REPEAT** button on the remote control again.

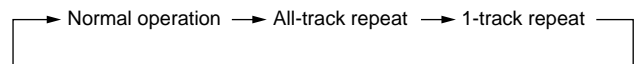

Random playback

Press the **RANDOM/MONO** button **18** on the remote control unit during the stop or play mode.

"RANDOM" appears on the display and the tracks on the disc are played in random order.

- The stop mode is set after all the tracks are played once.

The "RANDOM" display scrolls.



The normal playback information is displayed after the track to be played next has been selected.

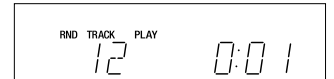

- To return to normal playback, press the **RANDOM/MONO** button **18** on the remote control unit again.
- During random playback, one of the remaining tracks can be played by pressing the **SKIP** **▶▶** button on the set or the **SKIP** **▶▶** button on the remote control unit.
- If the **REPEAT** button **17** on the remote control unit is pressed to select all-track repeat playback, all the tracks are played once in random order, then all the tracks are played again in another order, and this operation is repeated.

Switching the CD information display

When the CD player is in the play or pause mode

Press the **DISPLAY** button **17** on the set or the **TIME** button **14** on the remote control unit.

Elapsed track time display

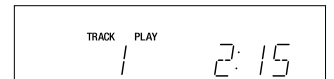

Remaining track time display

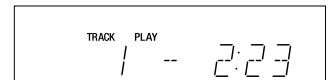

Total remaining time display



- If the **DISPLAY** button **17** on the set or the **TIME** button **14** on the remote control unit is pressed again, the display returns to the elapsed track time display.

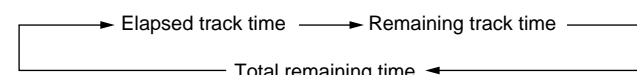

When the CD player is in the stop mode

The total number of tracks on the disc and their total playing time are displayed.

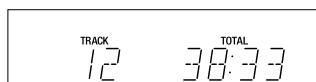

- The display does not change even if the **DISPLAY** button **[17]** on the set or the **TIME** button **[14]** on the remote control unit is pressed.

Programmed playback of CDs

Programming tracks

Use the following procedure to program up to 30 tracks to play in the desired order.

- With the CD player in the stop mode, press the **PROG/MEMO** button **[16]** on the remote control unit.
- Use the number buttons (0 to 9) **[3]** or **SKIP** buttons **▶▶** and **◀◀** on the remote control unit or the **SKIP** buttons **▶▶** and **◀◀** on the set to specify the tracks to be set in the program. (When specifying two-digit track numbers using the number buttons (0 to 9) **[3]** on the remote control unit, press the second button within two seconds.)
- Each time a track is specified, the display first shows that track number then the total number of programmed tracks and their total playing time.

Display during programming standby

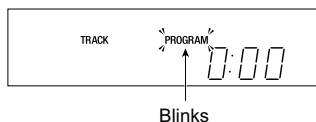

Display when track No. 5 is selected

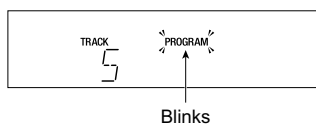

Display after the first track has been programmed

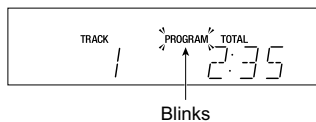

- After programming all the desired tracks, press the **PROG/MEMO** button **[16]** to set the program. The set returns to the stop mode.
- Even after the program has been set, other tracks can be added to the existing program by pressing the **PROG/MEMO** button **[16]** on the remote control unit again.

Playing the program

Press the **PLAY/PAUSE** button **▶/||** on the set or the **PLAY** button **▶** on the remote control unit after setting the program or during programming to begin programmed playback.

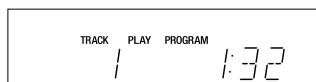

- Programmed editing is possible by conducting the editing operation after programming.

Checking the program

Press the **PROG/MEMO** button **[16]** on the remote control unit for at least two seconds during programmed playback or in the stop mode. The number of the track in the program and the track number appear on the display.

Use the **SKIP** buttons **▶▶** and **◀◀** on the set or the **SKIP** buttons **▶▶** and **◀◀** on the remote control unit to change the display in the programmed order.

Clearing the entire program

In the stop mode, press the **STOP** button **■** on the set or the **STOP** button **■** on the remote control unit. During playback, press the **STOP** button twice.

Clearing specific tracks from the program

- In the stop mode, press the **PROG/MEMO** button **[16]** on the remote control unit for at least two seconds to set the program checking mode.
- Use the **SKIP** buttons **▶▶** and **◀◀** on the set or the **SKIP** buttons **▶▶** and **◀◀** on the remote control unit to display the track to be cleared.
- Press the **CANCEL** button **[15]** on the remote control unit while the track to be cleared is displayed.

Edit playback

This feature enables editing in a simple procedure when recording a disc sound onto a tape or MD.

One of the three edit play modes, **NORMAL EDIT**, **FULL EDIT** and **MD EDIT**, can be selected by pressing the **EDIT** button.

NORMAL EDIT

When recording CD tracks onto a tape, the tracks are allocated to tape sides A and B according to the tape length, and they are played and recorded while leaving a blank space of 4 seconds between every track.

- In stop mode, press the **EDIT** button to select **NORMAL EDIT**.

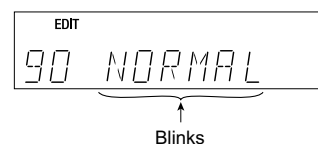

- Set the recording length of the tape. Press a **SKIP** buttons **▶▶** and **◀◀** to select the approximate tape length from 90, 60 and 46, then press one of numeric buttons (0 to 9), fast **FORWARD** button or **REWIND** button of the remote control unit to set the last figure of the tape length.

- Press the **PLAY/PAUSE** button **▶/||** of the main unit or the **PLAY** button **▶** of the remote control unit. Edit playback starts. When the tracks to be accommodated in tape side A have been played, the CD player enters pause mode at the beginning of the first track to be recorded on tape side B.

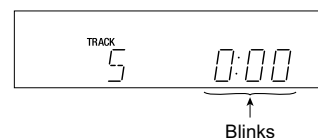

- The recording level of the tape deck (SD) should be adjusted before entering the edit play mode. (For the recording level adjustment, refer to the tape deck (SD) instruction manual.)
- When the tape side is reversed automatically or when you press the **PLAY/PAUSE** button **▶/||** of the main unit or the **PAUSE** button **||** of the remote control unit, edit playback for tape side B starts. When all tracks have been played, the CD player exits from the edit play mode and enters stop mode.
- By programming desired tracks before proceeding to edit playback, the programmed tracks can be recorded automatically in the programmed order.

FULL EDIT

When recording CD tracks onto a tape, the tracks are allocated to tape sides A and B, and they are played and recorded by also using the erase function while leaving a blank space of 4 seconds between every track.

1. In stop mode, press the **EDIT** button to select FULL EDIT.

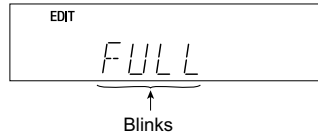

2. Press the **PLAY/PAUSE** button ►/|| of the main unit or the **PLAY** button ► of the remote control unit. When the tracks allocated for tape side A have been played, the CD player enters pause mode at the beginning of the track which was interrupted at the end of side A, until the recording of side B starts.

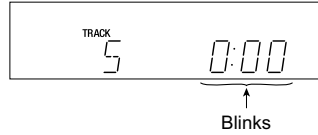

(During this pause, the track which was interrupted at the end of side A is erased. After this, recording of side B starts with the track erased above.)

- The recording level of the tape deck (SD) should be adjusted before entering the edit play mode. (For the recording level adjustment, refer to the tape deck (SD) instruction manual.)
3. When all tracks have been played, the CD player exits from the edit play mode and enters stop mode.
 - By programming desired tracks before proceeding to edit playback, the programmed tracks can be recorded automatically in the programmed order.

MD EDIT

When recording CD tracks onto a MD, this feature checks the available recording time of the MD and records the corresponding number of CD tracks to the available recording time. Recording of the only one track can be easily done.

1. In stop mode, press the **EDIT** button to select MD EDIT. (This mode is activated when the blinking ends.)

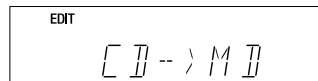

- The MD is checked during the blinking of the arrow. If the MD is not available for recording, the operation returns to the edit mode selection.

2. Press the **PLAY/PAUSE** button ►/|| of the main unit or the **PLAY** button ► of the remote control unit to start recording.

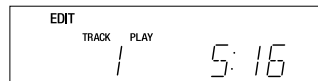

- By pressing a skip button to select a track before pressing the **PLAY/PAUSE** button ►/|| of the main unit or the **PLAY** button ► of the remote control unit, only the selected track can be recorded.

3. Before the start of recording, a message would be displayed if the available recording time of the MD is shorter than the playing time of the CD tracks.

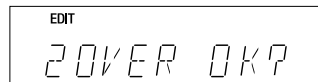

- By pressing the **PLAY/PAUSE** button ►/|| of the main unit or the **PLAY** button ► of the remote control unit, tracks can be recorded until the available recording time of the MD expires.

4. If the message is displayed, pressing the **PROG** button of the remote control unit allows to enter the program mode. (Program desired tracks in the same procedure as for normal programming.) After programming, press the **PLAY/PAUSE** button ►/|| of the main unit or the **PLAY** button ► of the remote control unit to start recording.

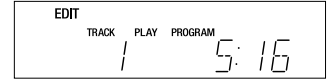

- If the available recording time of the MD is still shorter than the play time of the programmed tracks, the same message would be displayed again.
5. When the CD tracks have been played or the available recording time of the MD has expired, the CD player enters stop mode.

TROUBLESHOOTING

Should faults occur, it is in many cases not necessary to consult your dealer or Marantz technical service department. On the basis of the following checks you will be able to rectify a number of faults yourself without difficulty.

If the fault cannot be remedied after the following checks, please consult your dealer or nearest Marantz service agent.

Does sound come from only one side?

- Check the connections of the loudspeaker which is not working.
- Check the connections between the sound source and receiver.
- If using headphones, check that the plug is properly inserted into the jack.

Does the receiver hum, buzz or howl during recording or playback?

- Check the earth (GND) connection of the record player.
- Are the connection plugs pushed far enough into the jacks?
- Keep the connection cable to the record player as far away as possible from the mains power cable (in case of hum) or TV circuits (in case of buzz).
- The receiver may howl as a result of acoustic feedback from the loudspeakers to the record player. This occurs mainly at higher volumes.
In this case change the positioning of the loudspeakers.

You cannot hear anything, and no indicator lights up?

- The receiver is not switched on
- The receiver is not connected to a mains power outlet.
- The mains power outlet is not live.

You cannot hear anything, but an indicator lights up?

- Are the function buttons in the correct position?
- Is the selected sound source functioning properly?
- Is the volume control high enough?

Do not keep it in the maximum position!

- Are the loudspeakers connected properly?
Before you check this, ensure that the receiver is switched off.

Was the recording unsuccessful?

- Faulty operation of the signal source to be recorded.

Remote control is not working.

- Check that the batteries of the remote control are not exhausted.
If they are, replace them with two new batteries.

Troubles occurring during CD playback

A CD cannot be played.

- Is the CD loaded properly?
Place the CD with the label side facing up.
- Is the CD dirty?
Clean the CD.
- Is the CD scratched or otherwise damaged?
Use another CD.

CD playback stops in the middle or the sound is intermittent.

- Is the CD dirty?
- Is the CD scratched or otherwise damaged?
- Is the CD warped?

CARE AND MAINTENANCE

The section describes the care and maintenance tasks that must be performed to optimize the operation of your Marantz equipment.

CLEANING OF EQUIPMENT EXTERNAL SURFACES

The exterior finish of your unit will last indefinitely with proper care and cleaning. Never use scouring pads, steel wool, scouring powders or harsh chemical agents (e.g., lye solution), alcohol, thinners, benzine, insecticide or other volatile substances as these will mar the finish of the equipment. Likewise, never use cloths containing chemical substances. If the equipment gets dirty, wipe the external surfaces with a soft, lint-free cloth.

If the equipment becomes heavily soiled:

- dilute some washing up liquid in water, in a ratio of one part detergent to six parts water.
- dip a soft, lint free in the solution and wring the cloth out until it is damp.
- wipe the equipment with the damp cloth.
- dry the equipment by wiping it with a dry cloth.

REPAIRS

Only the most competent and qualified service technicians should be allowed to service the equipment. The Marantz company and its factory-trained warranty station personnel have the knowledge and special facilities needed for repair and calibration of this precision equipment. After the warranty period has expired, repairs will be performed for a charge if the equipment can be returned to normal operation.

In the event of difficulty, refer to your dealer or write directly to the nearest location to you that is listed on the Marantz Authorised Service Station list. If writing, please include the model and serial number of the equipment together with a full description of what you think is abnormal about the equipment's behaviour.

MODEL CR2020 TECHNICAL SPECIFICATIONS

FM TUNER SECTION

Frequency range	87.5 108 MHz
Sensitivity	19.2 dBf
S/N (Mono/Stereo)	75/65 dB
T.H.D.	0.3/0.6%
Selectivity at 98 MHz (± 400 kHz)	65 dB

AM TUNER SECTION

Frequency range	
U version	520 1710 kHz
K version	531 1602/520 1710 kHz
Sensitivity	400 μ V/m
S/N	50 dB

AMPLIFIER SECTION

Power output at 6 Ω	25 W
T.H.D. at 6 Ω rated RMS output	0.06%
Input sensitivity : AUX, TAPE, MD	180 mV/47 k Ω
S/N (IHF A) : AUX, TAPE, MD	80 dB

CD PLAYER SECTION

Frequency range	20 Hz 20 kHz
Dynamic range	85 dB
S/N	85 dB
Channel Separation	85 dB
T.H.D.	0.015%

POWER REQUIREMENTS

U version	120 V AC, 60 Hz
K version	115/220 230 V AC, 50/60 Hz

DIMENSIONS

Width	422 mm
Height	76 mm
Depth	314 mm
WEIGHT	6.2 kg

SUPPLIED ACCESSORIES

- Remote controller (RC2020CR) \times 1
- AAA (R03) Battery \times 2
- FM antenna \times 1
- AM loop antenna \times 1

Specifications subject to change without prior notice.

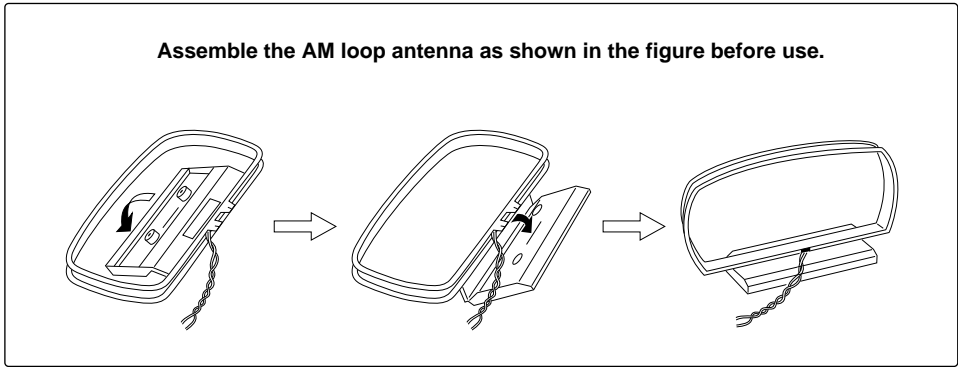
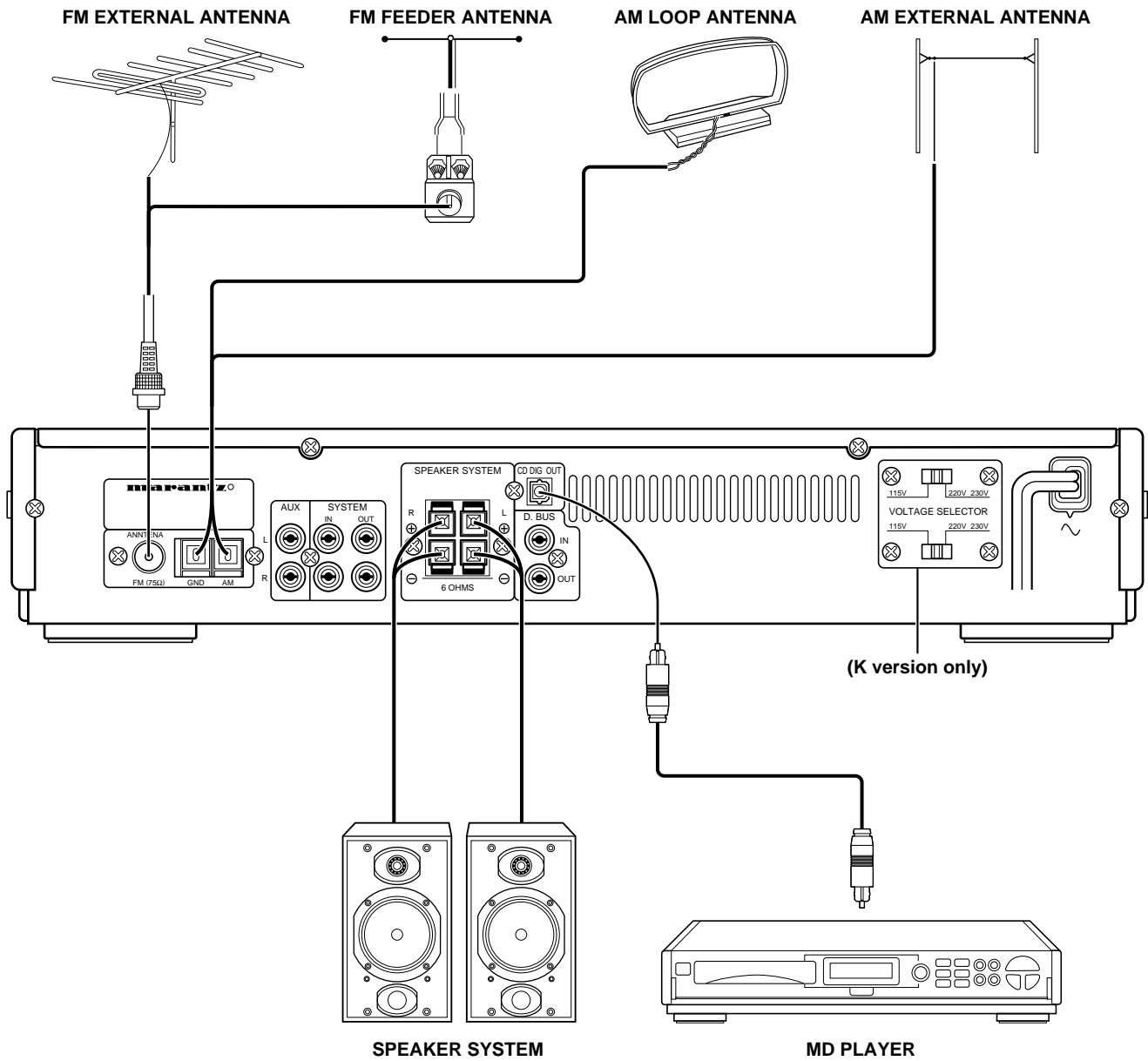

Figure 3

marantz® is a registered trademark.